

# SCANNER

Operating Manual – SICK ICR620E



Copyright by Carl Valentin GmbH / 7960081.0819

Information on the scope of delivery, appearance, performance, dimensions and weight reflect our knowledge at the time of printing.

We reserve the rights to make modifications.

All rights, including those regarding the translation, are reserved.

No part of this document may be reproduced in any form (print, photocopy or any other method) or edited, copied or distributed electronically without written permission from Carl Valentin GmbH.

Due to the constant further development of our devices discrepancies between manual and device can occur.

Please check [www.carl-valentin.de](http://www.carl-valentin.de) for the latest update.

### **Trademarks**

All named brands or trademarks are registered brands or registered trademarks of their respective owners and may not be separately labelled. It must not be concluded from the missing labelling that it is not a registered brand or a registered trademark.



### **Carl Valentin GmbH**

Postfach 3744  
78026 Villingen-Schwenningen  
Neckarstraße 78 – 86 u. 94  
78056 Villingen-Schwenningen

Phone +49 7720 9712-0  
Fax +49 7720 9712-9901

E-Mail [info@carl-valentin.de](mailto:info@carl-valentin.de)  
Internet [www.carl-valentin.de](http://www.carl-valentin.de)

## Table of Contents

|          |  |           |
|----------|--|-----------|
| <b>1</b> | <b>General Notes</b> .....                   | <b>5</b>  |
| 1.1      | Environmentally-Friendly Disposal .....      | 5         |
| 1.2      | Product Description .....                    | 6         |
| <b>2</b> | <b>Technical Data</b> .....                  | <b>7</b>  |
| <b>3</b> | <b>Installation of Scanner Bracket</b> ..... | <b>9</b>  |
| 3.1      | Spectra II .....                             | 9         |
| 3.2      | Vario III .....                              | 10        |
| <b>4</b> | <b>Configuration</b> .....                   | <b>11</b> |
| 4.1      | Settings of the Scanner Software.....        | 11        |
| 4.1.1    | Reading Configuration .....                  | 12        |
| 4.1.2    | Code Configuration .....                     | 14        |
| 4.1.3    | Data Processing .....                        | 15        |
| 4.1.4    | Network/Interfaces/Ios .....                 | 18        |
| 4.2      | Saving the Settings in the Scanner .....     | 19        |
| 4.3      | Loading a Configuration File .....           | 19        |
| <b>5</b> | <b>Function Menu Scanner</b> .....           | <b>21</b> |
| 5.1      | Scanner Mode .....                           | 21        |
| 5.2      | Scanner Type .....                           | 22        |
| 5.3      | Scanner Setup.....                           | 22        |
| 5.4      | Scan Offset.....                             | 22        |
| 5.5      | Scan Length .....                            | 23        |
| 5.6      | Scan Mode .....                              | 23        |
| 5.7      | Scan Delay .....                             | 24        |
| 5.8      | Scan Timeout .....                           | 24        |
| 5.9      | Interface Parameter .....                    | 24        |
| <b>6</b> | <b>Parameter Sets for Scanner Mode</b> ..... | <b>25</b> |
| 6.1      | Scanner Variable .....                       | 27        |
| <b>7</b> | <b>Error Messages</b> .....                  | <b>29</b> |
| <b>8</b> | <b>Index</b> .....                           | <b>31</b> |



## 1 General Notes

By means of the scanner option the immediate verification of printed bar codes is possible. Moreover errors such as defective printhead, transfer ribbons etc. can be avoided.

The bar code scanner is a state-of-the-art device which complies with the recognized safety-related rules and regulations. Despite this, a danger to life and limb of the user or third parties could arise and the bar code scanner or other property could be damaged while operating the device.

The bar code scanner may only be used while in proper working order and for the intended purpose. Users must be safe, aware of potential dangers and must comply with the operating instructions. Faults, in particular those which affect safety, must be remedied immediately.

### 1.1 Environmentally-Friendly Disposal

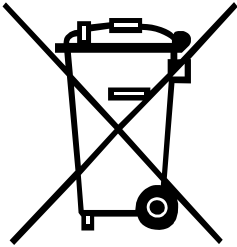

Manufacturers of B2B equipment are obliged to take back and dispose of old equipment that was manufactured after 13 August 2005. As a principle, this old equipment may not be delivered to communal collecting points. It may only be organised, used and disposed of by the manufacturer. Valentin products accordingly labelled can therefore be returned to Carl Valentin GmbH.

This way, you can be sure your old equipment will be disposed of correctly.

Carl Valentin GmbH thereby fulfils all obligations regarding timely disposal of old equipment and facilitates the smooth reselling of these products. Please understand that we can only take back equipment that is sent free of carriage charges.

The electronics board of the printing system is equipped with a battery. This must only be discarded in battery collection containers or by public waste management authorities.

Further information on the WEEE directive is available on our website [www.carl-valentin.de](http://www.carl-valentin.de).

## 1.2 Product Description



**Figure 1**

Intelligent decoding algorithms for maximum reading performance and high throughput, even with highly reflective or contaminated codes.

Variable illumination concept ensures stable reading even in changing light conditions.

Maximum reliability on shiny or reflective surfaces thanks to flexible optical accessories.

Automated setup wizard with auto focus and aiming laser makes commissioning faster and more cost-effective.

## 2 Technical Data

| <b>Features</b>                        |  |
|--|--|
| Focus                                  | Adjustable focus (electric)  |
| Sensor                                 | CMOS matrix sensor, grey values  |
| Sensor resolution                      | 752 px x 480 px (WVGA)   |
| Internal lighting                      | Red  |
| Light source                           | Illumination LEDs: visible red light ( $\lambda = 617 \pm 15$ nm)<br>Feedback spot: visible green light ( $\lambda = 525 \pm 15$ nm) |
| LED class                              | 1 (IEC 62471:2006-07, EN 62471:2008-09)  |
| Scanning frequency                     | 25 Hz, WVGA resolution   |
| Code resolution                        | $\geq 0.1$ mm (valid for DataMatrix, PDF417 and 1D bar codes with good print quality)  |
| Reading distance                       | 40 mm ... 1,500 mm (valid for DataMatrix, PDF417 and 1D bar codes with good print quality)   |
| Lens                                   | Integrated   |
| Focal length                           | 7 mm   |
| <b>Mechanics/electronics</b>           |  |
| Electrical connection                  | 1 x 15-pin D-Sub HD male connector (0.9 m)   |
| Supply voltage                         | 10 V DC ... 30 V DC<br>when connecting to the printer: 24 V DC   |
| Power consumption                      | Typ 3 W  |
| Output current                         | $\leq 100$ mA  |
| Housing                                | Aluminum die cast  |
| Housing color                          | Light blue (RAL 5012)  |
| Enclosure rating                       | IP65 (EN 60529 (1991-10), EN 60529/A2 (2002-02))   |
| Protection class                       | III  |
| Electical safety                       | EN 60950-1 (2006-04) / EN 60950-1/A11 (2009-03)  |
| Weight                                 | 170 g  |
| Dimensions (L x W x H)                 | 71 mm x 43 mm x 35,6 mm  |
| MTBF                                   | 75,000 h   |
| <b>Performance</b>                     |  |
| Readable code structures               | 1D, Stacked, 2D  |
| Bar code types                         | GS1-128 / EAN 128, UPC / GTIN / EAN, 2/5 Interleaved, Pharmacode, GS1 DataBar, Code 39, Code 128, Codabar, Code 32, Code 93          |
| 2D bar code types                      | DataMatrix ECC200, GS1 DataMatrix, PDF417, PDF417 Truncated, QR-Code   |
| No. of codes per reading interval      | 1 ... 50   |
| No. of characters per reading interval | 500 (for multiplexer function in CAN operation)  |
| Transport speed                        | 2 m/s  |

| <b>Interfaces</b>                   |  |
|-------------------------------------|--|
| Serial                              | RS 232, RS 422   |
| Function                            | Host, AUX  |
| Data transmission range             | 0.3 kBaud ... 115.2 kBaud, AUX: 57.6 kBaud (RS-232)                                |
| USB                                 |  |
| Remark                              | USB 2.0 (for parameterization only)  |
| Function                            | AUX  |
| Reading pulse                       | Digital inputs, non-powered, serial interface, CAN, auto pulse, presentaiton mode  |
| Optical indicators                  | 16 LEDs (5 x status display, 10 x LED bar graph, 1 green feedback spot)            |
| Acoustic indicators                 | Beeper/buzzer (can be switched off, can be assigned a function to signal a result) |
| Operating elements                  | 2 buttons (choose and start/stop functions)  |
| Configuration software              | SOPAS ET   |
| Data storage and retrieval          | Image and data storage via micro SD memory card and external FTP                   |
| Maximum encoder frequency           | 300 Hz   |
| Exernal illumination control        | Via digital ouput (max 24 V trigger)   |
| <b>Ambient data</b>                 |  |
| Electromagnetic compatibility (EMV) | EN 61000-6-2 (2006-03) / EN 61000-6-2 (2009-05)                                    |
| Vibration resistance                | EN 60068-2-6:2008-02   |
| Shock resistance                    | EN 60068-2-27:2009-05  |
| Ambient operating temperature       | 0 °C ... +50 °C  |
| Storage temperature                 | -20 °C ... +70 °C  |
| Permissible relative humidity       | 90 %, non-condensing   |
| Ambient light immunity              | 2,000 lx, on code  |



### 3 Installation of Scanner Bracket

#### 3.1 Spectra II

**DANGER!**

Risk of death via electric shock!

- ⇒ Before installation/dismantling of the option scanner, disconnect the label printer from the mains supply and wait for a moment until the power supply unit has discharged.

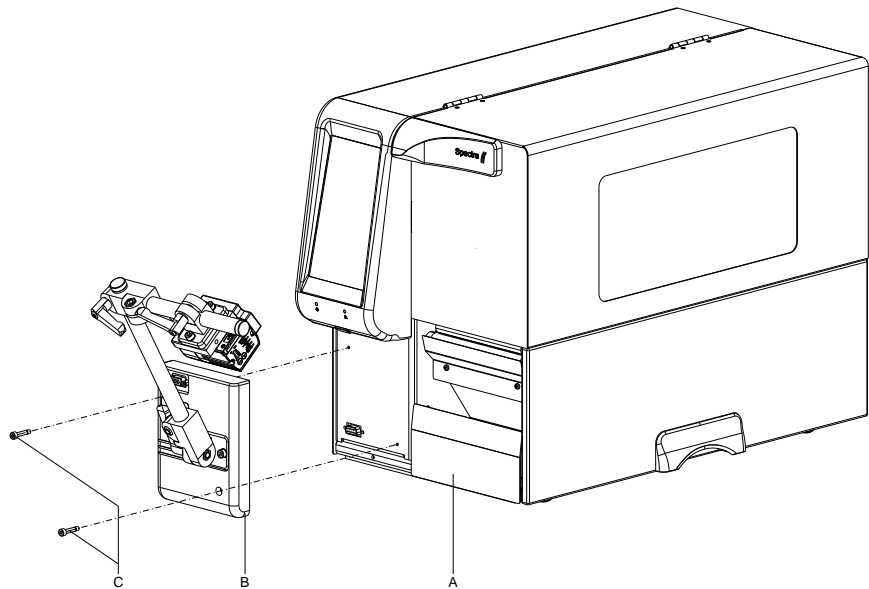

**Figure 2**

1. Open the right printer cover.
2. Remove the lower front panel.
3. Fasten the scanner bracket (B) with the fixing screws (C) at the printer (A).  
It is important to pay attention to the plug connection!
4. Insert the label material (as described in the operating manual).

### 3.2 Vario III

**DANGER!**

Risk of death via electric shock!

- ⇒ Before installation/dismantling of the option scanner, disconnect the label printer from the mains supply and wait for a moment until the power supply unit has discharged.

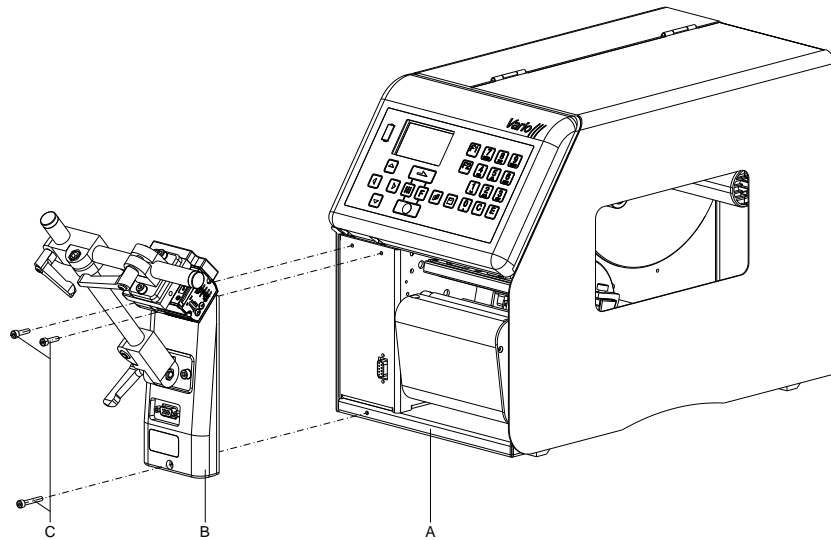

**Figure 3**

1. Open the right printer cover.
2. Remove the lower front panel.
3. Fasten the scanner bracket (B) with the fixing screws (C) at the printer (A).  
It is important to pay attention to the plug connection!
4. Insert the label material (as described in the operating manual).

## 4 Configuration

The ICR620E must be configured accordingly to operate on a Spectra II or Vario III. For this, the PC software *SOPAS Engineering Tool* can be downloaded from the SICK website ([www.sick.com](http://www.sick.com)). After installing the software, the scanner must be connected to the PC with a micro USB cable. The micro USB socket is located on the back of the scanner behind a black cover that is attached with two screws. To release the two screws, a corresponding key is supplied with the scanner.

Spectra II: Alternatively, the scanner can be configured using the serial interface (D-SUB 9-pin) that is integrated in the scanner bracket with a 1:1 cable.

### 4.1 Settings of the Scanner Software

After starting the software SOPAS ET, it searches for the connected scanner and displays it on the user interface.



**Figure 4**

By double-clicking on the scanner symbol or by clicking 'Open device window ...' in the context menu, the device window is opened (standard or advanced). In the advanced display, a tree structure is displayed on the left side. Different parameter ranges can be selected there.

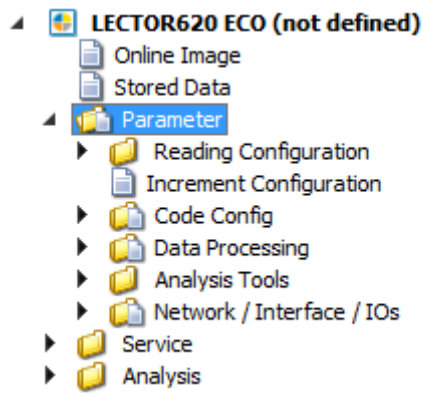

**Figure 5**

After selecting a parameter range, the corresponding parameters are displayed on the right side and can be changed there.

### 4.1.1 Reading Configuration

Various settings regarding camera and illumination can be made.

#### Camera

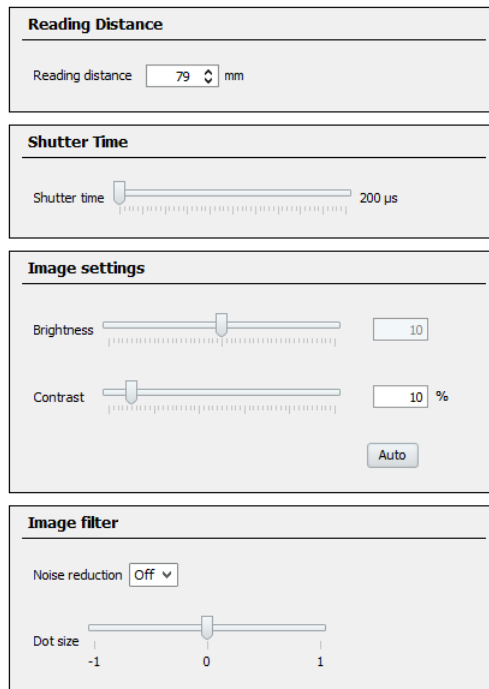

**Figure 6**

**Illumination**

**Illumination**

Internal Left ▾

External Off ▾

Green feedback spot Good Read ▾ Duration 500 ms

---

**Increase Performance**

Set frame rate (f) manually

Used frame rate 0 Request

---

Image rotation 180°

Image region of interest

0 % 100 %

0 % 100 %

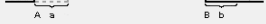

**Figure 7**

**Object trigger control**

Various settings regarding the signal to start the scanner can be made.

**Start/Stop of Object Trigger**



Trigger delay Time controlled ▾

A. Start by User defined command ▾ a. Start delay 0 ms

B. Stop by Trigger source ▾ or Good Read ▾ or Not defined ▾ b. Stop delay 0 ms

Trigger echo on

Start command STX 21 ETX  
bx2 bx3

Stop command STX 22 ETX  
bx2 bx3

Reading gate on Reading gate off

---

**Trigger Distribution**

Distribute on Disabled ▾

**Figure 8**

Do not change the setting 'Start by / User defined command' because the scanner is to be controlled by the printer which sends the start command (STX)21(ETX) and the stop command (STX)22(ETX).

### 4.1.2 Code Configuration

Settings regarding the codes to be scanned can be made. An automatic configuration can be performed by placing an existing bar code under the scanner.

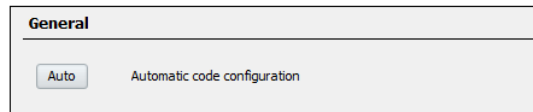
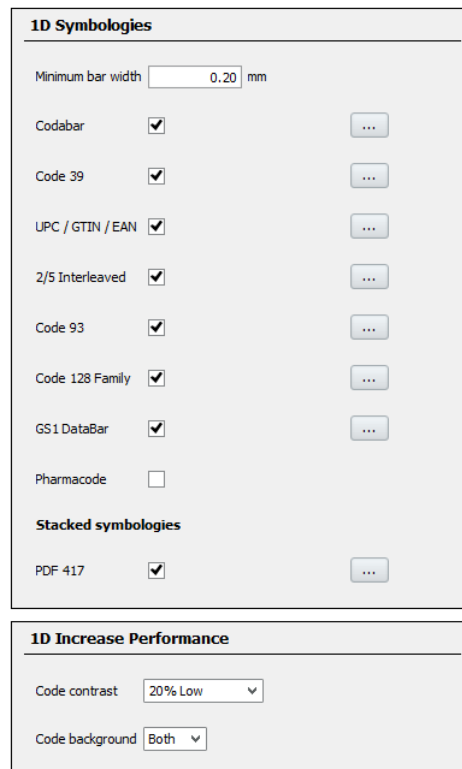

**Figure 9**

However, it is also possible to change settings manually for the individual code types.

#### Settings for 1D bar codes

Settings for one-dimensional bar codes can be made. The default settings are selected in such a way that the common 1D bar codes can be read.



**Figure 10**

## Settings for 2D bar codes

Settings for two-dimensional bar codes can be made.

The image shows two configuration panels for 2D bar codes. The top panel, titled "2D Symbologies", includes a "Minimum cell size" input field set to "0.20 mm", and checkboxes for "Data Matrix" and "QR Code", both of which are checked. To the right of each checkbox are small icons of the respective code types and a three-dot menu button. The bottom panel, titled "2D Increase Performance", contains several dropdown menus: "Code contrast" is set to "20% Low", "Code background" is set to "Both", and "Code appearance" is set to "Normal". There is also an unchecked checkbox for "Accelerated code search".

Figure 11

### 4.1.3 Data Processing

Settings for the data processing can be adjusted here.

The image shows two configuration panels for data processing. The top panel, titled "Collection of Data", has a "Timeout" input field set to "50 ms". The bottom panel, titled "Code summarization", has an unchecked checkbox for "Separate codes depending on position".

Figure 12

## Output control

Settings for the output control can be adjusted here.

The image shows the "Output Control" settings panel. It contains three dropdown menus: "Control" is set to "Time controlled", "Data transmission point" is set to "As soon as possible", and "Output Condition" is set to "Good Read". There is also a "Data output mode" dropdown menu set to "Single".

Figure 13

The default settings for the data transmission point ('as soon as possible') and the output condition ('Good Read') should not be changed.

**Evaluation conditions**

**Condition for Good-Read**

Use min./max. number of codes

Check min. number of valid codes  Minimum

Check max. number of valid codes  Maximum

**Evaluation Conditions**

Conditions

Match1: (Code content  $\neq$  123\* (Wildcards)) And (Code valid (1 or 0) > 0) [Code related]

MultCodes1: (Number of valid codes > 2) [Object related]

TeachIn1: (Code length  $\geq$  4) And (Code length  $\leq$  50) [deact: Always false]

TeachIn2: (Code length  $\geq$  4) And (Code length  $\leq$  50) [deact: Always false]

**Figure 14**

Normally no settings are necessary. At print start, the printer sends the number of codes to be scanned (min/max) to the scanner.

**Matchcode**

**Match-code teach-in 1 (Standard)**

Activate teach-in mode  or Teach-in via function buttons

Teach-in Condition  Invert condition

Teach-in code content  Teach-in code ID  Teach-in code length

**Match-code teach-in 2 (Additional)**

Activate teach-in mode

**General Match-code teach-in settings**

Start teach-in

Allowed code types

Code configuration

Save permanent

**Figure 15**

Normally no settings are necessary.



**Filter/sorter for the output formatting**

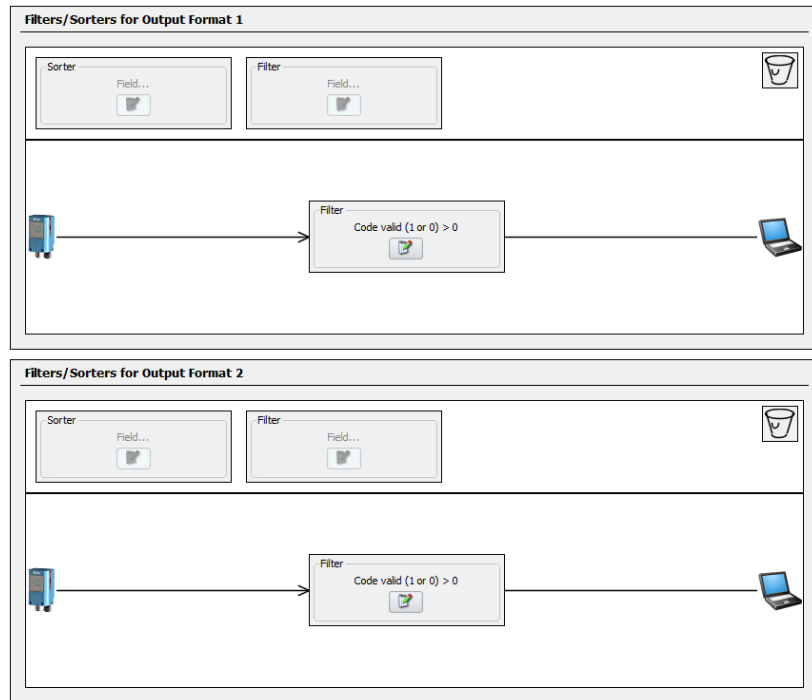

**Figure 16**

Normally no settings are necessary.

**Output format**

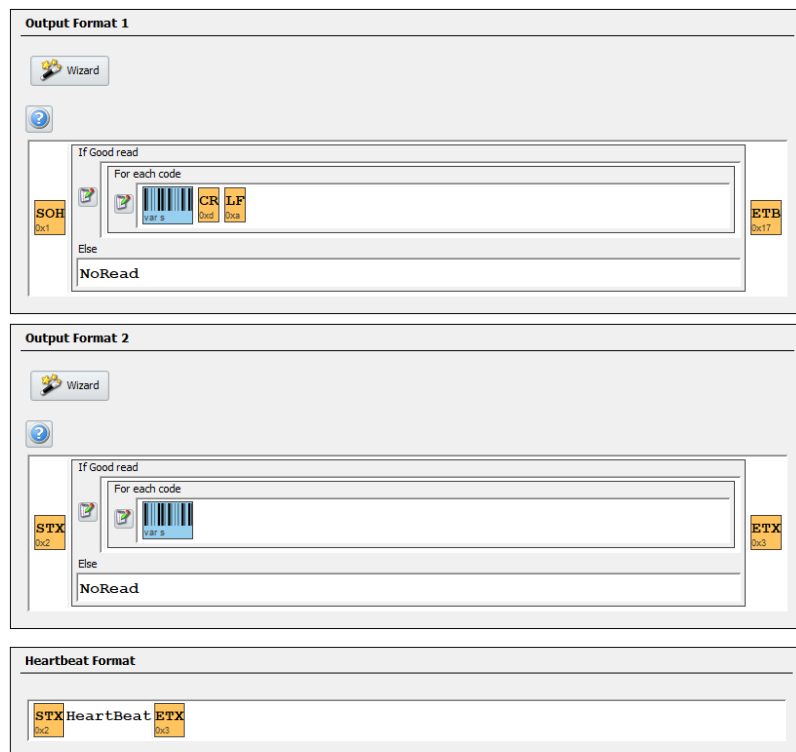

**Figure 17**

No changes should be made here, otherwise the communication between printer and scanner may not work.

## 4.1.4 Network/Interfaces/Ios

### Serial

| Serial Host         |                          |
|---------------------|--------------------------|
| Output Format       | Output format 1          |
| Baud rate           | 9600                     |
| Stop bits           | 1                        |
| Data bits / parity  | 8 data bits / no parity  |
| Hardware            | RS232                    |
| Enable heartbeat    | <input type="checkbox"/> |
| Usage of Input Data | No External Input Data   |

| Serial Auxiliary    |                          |
|---------------------|--------------------------|
| Output Format       | Output format 1          |
| Enable heartbeat    | <input type="checkbox"/> |
| Usage of Input Data | No External Input Data   |

**Figure 18**

The interface Serial Host is used as connection between the scanner and printer. If the interface parameters (baud rate, etc) are changed, they must be adjusted accordingly in the function menu 'Scanner' of the printer.

### Digital inputs

| Sensor / Input 1 |              |            |
|------------------|--------------|------------|
| Sensitivity      | Edge         | Logic      |
|                  | Not inverted | Debouncing |
|                  |              | 10 ms      |

| Sensor / Input 2 |              |            |
|------------------|--------------|------------|
| Sensitivity      | Edge         | Logic      |
|                  | Not inverted | Debouncing |
|                  |              | 10 ms      |

**Figure 19**

No settings are necessary as the scanner is not controlled via the digital inputs.

**Digital outputs / beeper**

| Output / Result 1 |                |
|-------------------|----------------|
| Active            | Device ready ▼ |
| Logic             | Not inverted ▼ |

| Output / Result 2 |                   |
|-------------------|-------------------|
| Active            | Good Read ▼       |
| Inactive          | Timer/Tracking ▼  |
| Logic             | Not inverted ▼    |
| Control           | Time controlled ▼ |
| Duration          | 100 ms            |

| Beeper |             |
|--------|-------------|
| Beeper | Good Read ▼ |
| Volume | Off ▼       |

**Figure 20**

No settings are necessary as the digital outputs are not used. If necessary, the beeper can be switched on as feedback from the scanner.

**4.2 Saving the Settings in the Scanner**

To save the settings in the scanner, in the menu under the device name (LECTOR620E), select the function 'Parameter/Save

permanent'. This can also be done with clicking on the symbol .

**4.3 Loading a Configuration File**

To load an existing configuration file from the PC, the function 'Device/Import SDV file ...' must be selected.

After selecting the file name (\*.sdv), the parameters are loaded and can be saved in the scanner as described above.



## 5 Function Menu Scanner

### 5.1 Scanner Mode

This display provides the possibility to set the desired scanner mode (Mode), the number of acceptable non-readable (NoRd) as well as the number of label feedings (Flab).

|                              |  |
|------------------------------|--|
| <b>Operating mode (Mode)</b> | 0 = Off  |
|                              | 1 = Mode 1 (data comparison), i.e. bar code data which was read by the scanner is compared with the printed data.  |
|                              | 2 = Mode 2 (check readability), i.e. it is only checked if the scanner can read the printed bar codes.   |
|                              | 3 = Mode 3 (check readability, graphic), i.e. it is only checked if the scanner can read the printed bar codes. This mode is to use if the bar code is available as graphic (e.g. printing with printer driver). In this case the printer cannot recognize that a bar code is placed onto the label. |

|                            |   |
|----------------------------|---|
| <b>Non-readable (NoRd)</b> | Indication of number of successive non readables, i.e. when the printer indicates an error message.<br>Value range: 0 ... 9 |
|                            | 1 = the printer stops at the first label which cannot be red from the scanner and shows an error message.                   |
|                            | 0 = the printer do not stop at non-readable. A message appears at the display only.   |

|                          |   |
|--------------------------|---|
| <b>Label feed (VEti)</b> | In many cases the scanner cannot be positioned directly on the printhead. In this case, use this parameter to set a label feed between 1 and 5. The illustration shows the meaning of this parameter. |
|--------------------------|---|

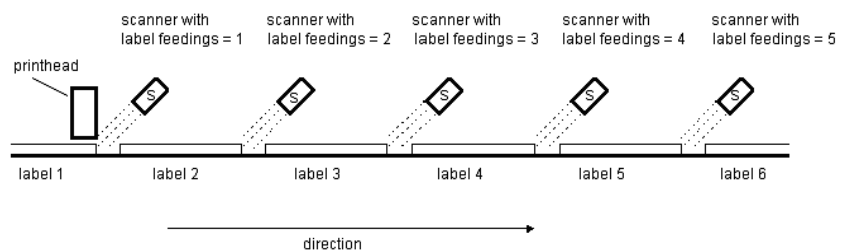

## 5.2 Scanner Type

The different scanners are controlled by different commands and/or the scanners return the scanned data in different manners. Therefore this window provides the possibility to select the scanner model corresponding to the connected scanner.

## 5.3 Scanner Setup

With this parameter, the position of the scanner can be set. However, first of all you have to connect the scanner, select the corresponding scanner model in 'scanner type' window, set the corresponding interface and correctly to set the parameters in the 'interface parameter' window.

After pressing the enter key (red button) the scanner is set to on and tries to read bar codes continuously. In case a bar code is read then the read data is indicated in the display and the scanner is immediately again set to on. Is the scanner in the correct position it starts to flicker. Is the scanner not in the correct position then it is set to on as long as again a bar code is read. The scanner is to position in the way that at feeding labels of 1 the bar code is directly read at the printhead.

## 5.4 Scan Offset

In scan mode 'while print' the scanner is switched On if the first pixel line is printed (= of bar code which is to scan). The scanner is switched Off either by reading the bar code (Good Read) or explicitly by the printer, if the last pixel line is printed (= of the bar code which is to scan - No Read). By means of this value the switch On and Off position of scanner in printing direction can be shifted.

In scan mode 'after print), the label is advanced by the set offset, before the scanner is switchen On and after scanning again retracted.

## 5.5 Scan Length

If this parameter is set to 0 (AUTO), the switch on and off position of scanner is calculated by means of position and height of bar code onto the label. If the parameter Scan Length is not 0, so this defines the length of scan sector. The start of scan sector is then set by the parameter 'Scan Offset'.

This parameter is not relevant in scan mode 'after print'

The following drawing shows the meaning of the parameters 'Scan Offset' and 'Scan length'.

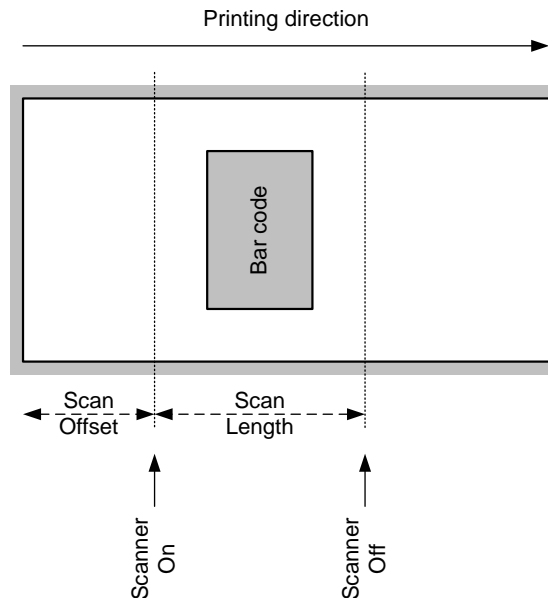

Figure 21

## 5.6 Scan Mode

With this parameter can be adjusted, at which time the scanning of the bar code is to be effected - during printing or after printing.

**While printing** The scanning of bar code is effected while the label is printed. By means of the parameter 'number of feeding labels' can be defined which label should be scanned. With the parameters 'Scan offset' and 'Scan length' the scan sector can be specified.

**After printing** The scanning of bar code is effected after the label was printed. With the parameter 'Scan delay' the time can be varied between printing the label and switching on the scanner. With the parameter 'Scan timeout' the time can be specified which is available for scanning the label. After successful scanning of bar code the next label is printed and/or in dispensing mode the printer changes to 'waiting' mode.

## 5.7 Scan Delay

In scan mode 'after print' the scanner is switched On after the label was printed. With this value the time can be specified between printing the label and switching On the scanner.

This parameter is not relevant in scan mode 'while print'.

## 5.8 Scan Timeout

In scan mode 'after print' can be specified with this value the time which is available for scanning the label. If the parameter 'scan timeout' is set to 0, the printer waits until the bar code could be read. If the bar code is not read within the fixed time the printer switches Off the scanner again (non readable). When reaching the fixed number of consecutive non-readable an error message appears at the display.

This parameter is not relevant in scan mode 'while print'.

## 5.9 Interface Parameter

Set the parameter of serial interface at which the scanner is connected to the printer.

|               |   |
|---------------|---|
| COMx          | 0 = Off<br>1 = On<br>2 = On, no error message at interface errors |
| Baud rate     | 1200, 2400, 4800, 9600, 19200, 38400, 57600 Baud                  |
| P - Parity    | N = None<br>O = Odd<br>E = Even                                   |
| D – Data bits | 7, 8 Bits   |
| S – Stop bits | 1, 2 Bits   |



## 6 Parameter Sets for Scanner Mode

### Set scanner operating mode

|     |   |   |   |   |   |   |   |   |   |   |   |   |   |   |   |     |
|-----|---|---|---|---|---|---|---|---|---|---|---|---|---|---|---|-----|
| SOH | F | C | D | M | - | - | r | M | P | N | F | - | - | - | - | ETB |
|-----|---|---|---|---|---|---|---|---|---|---|---|---|---|---|---|-----|

M: 0 = Off

M: 1 = Mode 1 (data comparison)

M: 2 = Mode 2 (check only readability)

M: 3 = Mode 3 (check only readability, graphic)

P: 0 = Interface COM1

P: 1 = Interface COM2

This parameter is ignored because COM2 is always used as scanner interface

N: - = 0 bad readings (NoReads)

N: 0 = 1 bad readings

N: 1 = 2 bad readings

N: 2 = 3 bad readings

N: 3 = 4 bad readings

N: 4 = 5 bad readings

N: 5 = 6 bad readings

N: 6 = 7 bad readings

N: 7 = 8 bad readings

N: 8 = 9 bad readings

Number of consecutive bad readings after which an error message is displayed. With '-' (0 NoReads) no error message occurs, i.e. the print procedure is not interrupted. Only a warning will be shown on the display.

F: 0 = No label feed (FeedLabel)

F: 1 = Feed by 1 label

F: 2 = Feed by 2 labels

F: 3 = Feed by 3 labels

F: 4 = Feed by 4 labels

F: 5 = Feed by 5 labels

### Enquire scanner operating mode

|     |   |   |   |   |   |   |   |   |   |   |   |   |   |   |   |   |     |
|-----|---|---|---|---|---|---|---|---|---|---|---|---|---|---|---|---|-----|
| SOH | F | C | D | M | - | - | w | p | p | p | p | p | p | p | p | p | ETB |
|-----|---|---|---|---|---|---|---|---|---|---|---|---|---|---|---|---|-----|

### Answer

|     |   |   |   |   |   |   |   |   |   |   |   |   |   |   |   |   |   |     |
|-----|---|---|---|---|---|---|---|---|---|---|---|---|---|---|---|---|---|-----|
| SOH | A | M | P | N | F | - | - | - | - | p | p | p | p | p | p | p | p | ETB |
|-----|---|---|---|---|---|---|---|---|---|---|---|---|---|---|---|---|---|-----|

### Set scan offset

|     |   |   |   |   |   |   |   |   |   |   |   |   |   |   |   |     |
|-----|---|---|---|---|---|---|---|---|---|---|---|---|---|---|---|-----|
| SOH | F | C | D | M | A | - | r | N | N | N | N | - | - | - | - | ETB |
|-----|---|---|---|---|---|---|---|---|---|---|---|---|---|---|---|-----|

N = Scan offset in 1/10 mm

### Enquiry scan offset

|     |   |   |   |   |   |   |   |   |   |   |   |   |   |   |   |   |     |
|-----|---|---|---|---|---|---|---|---|---|---|---|---|---|---|---|---|-----|
| SOH | F | C | D | M | A | - | w | p | p | p | p | p | p | p | p | p | ETB |
|-----|---|---|---|---|---|---|---|---|---|---|---|---|---|---|---|---|-----|

### Antwort

|     |   |   |   |   |   |   |   |   |   |   |   |   |   |   |   |   |   |     |
|-----|---|---|---|---|---|---|---|---|---|---|---|---|---|---|---|---|---|-----|
| SOH | A | N | N | N | N | - | - | - | - | p | p | p | p | p | p | p | p | ETB |
|-----|---|---|---|---|---|---|---|---|---|---|---|---|---|---|---|---|---|-----|

N = Current scan offset in 1/10 mm

**Set scan length**

SOH F C D M B - r N N N N - - - - ETB

N = Scan length in 1/10 mm

**Enquiry scan length**

SOH F C D M B - w p p p p p p p p ETB

**Answer**

SOH A N N N N - - - - p p p p p p p p ETB

N = current scan length in 1/10 mm

**Set scan mode**

SOH F C D M C - r N N N N - - - - ETB

N: 0 = Scanning while printing

N: 1 = Scanning after printing

**Enquire scan mode**

SOH F C D M C - w p p p p p p p p ETB

**Answer**

SOH A N - - - - - p p p p p p p p ETB

N = current scan mode

**Set scan delay (scanning after printing)**

SOH F C D M D - r N N N N - - - - ETB

N = Scan delay in ms [0 ... 9990]

**Enquire scan delay**

SOH F C D M D - w p p p p p p p p ETB

**Answer**

SOH A N N N N - - - - p p p p p p p p ETB

N = Current scan delay in ms

**Set scan timeout (scanning after printing)**

SOH F C D M E - r N N N N - - - - ETB

N = Scan timeout in ms [0 ... 9990]

**Enquire scan timeout**

SOH F C D M E - w p p p p p p p p ETB

**Answer**

SOH A N N N N - - - - p p p p p p p p ETB

N = Current scan timeout in ms

**Set scanner type**

|     |   |   |   |   |   |   |   |   |   |   |   |   |   |   |   |     |
|-----|---|---|---|---|---|---|---|---|---|---|---|---|---|---|---|-----|
| SOH | F | C | D | M | F | - | r | N | N | N | N | - | - | - | - | ETB |
|-----|---|---|---|---|---|---|---|---|---|---|---|---|---|---|---|-----|

N: 5 = Zebra DS457

N: 6 = SICK ICR620

N: 7 = SICK CLV6XX

**Enquire scanner type**

|     |   |   |   |   |   |   |   |   |   |   |   |   |   |   |   |   |     |
|-----|---|---|---|---|---|---|---|---|---|---|---|---|---|---|---|---|-----|
| SOH | F | C | D | M | F | - | w | p | p | p | p | p | p | p | p | p | ETB |
|-----|---|---|---|---|---|---|---|---|---|---|---|---|---|---|---|---|-----|

**Answer**

|     |   |   |   |   |   |   |   |   |   |   |   |   |   |   |   |     |
|-----|---|---|---|---|---|---|---|---|---|---|---|---|---|---|---|-----|
| SOH | A | N | - | - | - | - | - | p | p | p | p | p | p | p | p | ETB |
|-----|---|---|---|---|---|---|---|---|---|---|---|---|---|---|---|-----|

N = Current set scanner type

## 6.1 Scanner Variable

In operating mode 1 (data comparison) the printer has to provide the possibility to define the order of bar code data to scan multiple codes onto a label. Because of this reason it is necessary to define the bar code data in the text statements as scanner 'variable'. The text statement has the following structure:

**Scanner variable**

|     |    |     |   |   |   |   |   |   |   |   |           |     |
|-----|----|-----|---|---|---|---|---|---|---|---|-----------|-----|
| SOH | BM | [n] | = | S | V | ( | a | ; | f | ) | text data | ETB |
|-----|----|-----|---|---|---|---|---|---|---|---|-----------|-----|

'=SV' Identification of scanner variable

a Field active

0 = not active

1 = active, i.e. the code is scanned

f Field number for definition of code order (1 ...)

**Examples**

Text fix:

(SOH)BM[1]=SV(1;1)123456(ETB)

Text variable (counter):

(SOH)BM[1]=SV(1;1)=CN(10;0;4;+1;1)0001(ETB)



## 7 Error Messages

| Error message      | Cause  | Remedy   |
|--------------------|--|--|
| 68 Scanner         | The connected bar code scanner signals a device error.   | Check the connection scanner/printer.<br>Check the scanner (dirty).  |
| 69 Scanner NoRead  | Bad print quality.<br>Printhead completely soiled or defective.<br>Print speed too high.   | Increase the contrast.<br>Clean the printhead or exchange (if necessary).<br>Reduce the print speed.   |
| 70 Scanner data    | Scanned data does not correspond to the data which is to print.  | Exchange printhead.  |
| 94 Scanner Timeout | The scanner could not read the bar code within the set timeout time.<br><br>Defective printhead.<br>Wrinkles in the transfer ribbon.<br>Scanner wrong positioned.<br>Timeout time too short. | Check the printhead.<br>Check the transfer ribbon.<br>Position the scanner correctly, corresponding to the set feeding.<br>Select longer timeout time. |



## 8 Index

### C

configuration ..... 11  
 configuration, settings scanner software. 11, 12, 13, 14, 15, 16, 17, 18, 19

### E

environmentally-friendly disposal ..... 5  
 error messages ..... 29

### F

function menu scanner  
   interface parameter..... 24  
   Scan delay ..... 24  
   scan length ..... 23  
   scan mode ..... 23  
   scan offset ..... 22  
   Scan timeout..... 24  
   scanner mode ..... 21  
   scanner setup ..... 22  
   type ..... 22

### G

general notes..... 5

### I

installation  
   Spectra II ..... 9  
   Vario III..... 10  
 integration..... 6

### P

parameter sets  
   scanner ..... 25, 26, 27  
   scanner variable ..... 27  
 product description ..... 6

### T

technical data ..... 7, 8



---

Carl Valentin GmbH  
Neckarstraße 78 – 86 u. 94 . 78056 Villingen-Schwenningen  
Phone +49 7720 9712-0 . Fax +49 7720 9712-9901  
info@carl-valentin.de . www.carl-valentin.de